

# LipuMax-P-B

## Product information for the product group

### ACO Product benefits

- For gully top designs for load class D 400, shaft has buoyancy safety up to the upper side of the shaft manhole cover without need for on-site concrete castings.
- Proven stability: 50 years

- Grease separator plant as per DIN EN 1825 and DIN 4040-100
- For underground installation
- Emptying and cleaning via shaft manhole cover
- Suitable top sections
  - Top sections

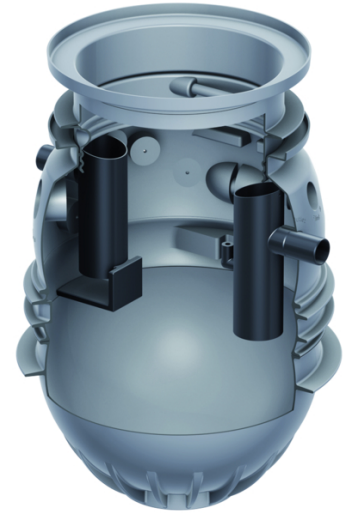

## Item Technical Data 3202.80.00



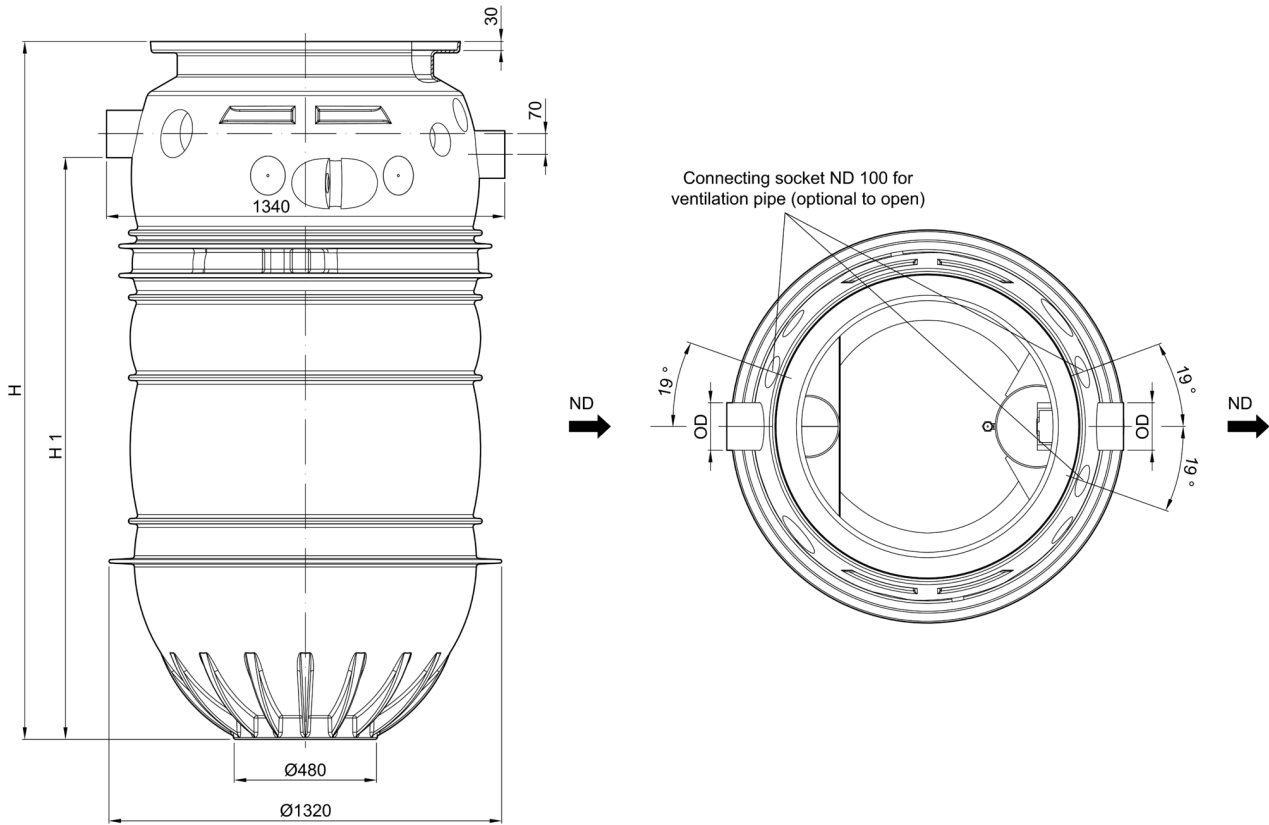

Nominal size	Inlet/ Outlet	Contents			Weight	
		Sludge trap	Grease store	Overall		
		[l]	[l]	[l]	[kg]	
NS 2	DN 100	245	270	720	63	11

**Dimensions**



Nominal size	Sludge trap	Dimensions		
		D [mm]	H [mm]	H1 [mm]
NS 2	245	110	1380	1020

**Accessories**

	Description	Used with	Weight [kg]	Item number
	<p><b>Extension 450</b></p> <ul style="list-style-type: none"> <li>■ Made from plastic, material polyethylene</li> <li>■ For fitting on upstream shaft for deep installations</li> <li>■ Structure height: 100 – 650 mm                             <ul style="list-style-type: none"> <li><input type="checkbox"/> (can be reduced to 45 mm by cutting off at cutting marks)</li> </ul> </li> <li>■ Max. two extension can be used</li> </ul>	<ul style="list-style-type: none"> <li>■ Sampling shaft</li> </ul>	8.8	3300.13.00
	<p><b>Grease layer thickness measuring device</b></p> <ul style="list-style-type: none"> <li>■ For electronic measurement of layer of grease</li> <li>■ Suitable for liquid and/or congealing grease</li> <li>■ Measuring device with plug and used connecting cable, length: 3 m</li> <li>■ With two voltage-free changeover contacts to display full warning (100%) and advance warning of fill level (80%)</li> <li>■ With visual display of fill level for advance warning and full warning</li> <li>■ With heated probe rod to increase reliability of operation</li> <li>■ Operating voltage: 230 V/50 Hz</li> <li>■ Max consumption approx. 12W</li> </ul>	<ul style="list-style-type: none"> <li>■ Grease separator LipuMax-P for underground installation</li> <li>■ LipuLift-P</li> </ul>		
	Cable length: 10 m		6.4	3300.11.70
	Cable length: 20 m		7.8	3300.11.71
	Cable length: 30 m		9.6	3300.11.72
	<p><b>Support ring</b></p> <ul style="list-style-type: none"> <li>■ Made from concrete</li> <li>■ Diameter: 625 mm</li> <li>■ Thickness: 60 mm</li> <li>■ Without seal</li> <li>■ Displacement-proof</li> <li>■ Height                             <ul style="list-style-type: none"> <li><input type="checkbox"/> 60 mm excluding mortar joints</li> <li><input type="checkbox"/> 70 mm including mortar joints</li> </ul> </li> </ul>	<ul style="list-style-type: none"> <li>■ Grease separator LipuMax-P for underground installation</li> <li>■ Lipulift-P Serie</li> <li>■ Starch separator FapuMax-P for underground installation</li> </ul>	50.0	8700.20.00
	<p><b>Support ring</b></p> <ul style="list-style-type: none"> <li>■ Made from concrete</li> <li>■ Diameter: 625 mm</li> <li>■ Thickness: 80 mm</li> <li>■ Without seal</li> <li>■ Displacement-proof</li> <li>■ Height                             <ul style="list-style-type: none"> <li><input type="checkbox"/> 80 mm excluding mortar joints</li> <li><input type="checkbox"/> 90 mm including mortar joints</li> </ul> </li> </ul>	<ul style="list-style-type: none"> <li>■ Grease separator LipuMax-P for underground installation</li> <li>■ Lipulift-P Serie</li> <li>■ Starch separator FapuMax-P for underground installation</li> </ul>	60.0	8700.20.10

	Description	Used with	Weight [kg]	Item number
 <p><b>Support ring</b></p> <ul style="list-style-type: none"> <li>■ Made from concrete</li> <li>■ Diameter: 625 mm</li> <li>■ Thickness: 100 mm</li> <li>■ Without seal</li> <li>■ Displacement-proof</li> <li>■ Height                             <ul style="list-style-type: none"> <li><input type="checkbox"/> 100 mm excluding mortar joints</li> <li><input type="checkbox"/> 110 mm including mortar joints</li> </ul> </li> </ul>		<ul style="list-style-type: none"> <li>■ Grease separator LipuMax-P for under-ground installation</li> <li>■ Lipulift-P Serie</li> <li>■ Starch separator FapuMax-P for under-ground installation</li> </ul>	70.0	8700.20.20

You can find further accessories under → <https://www.buildingdrainage.aco/search/?q=3202.80.00>