

LipuMax-P-B

Product information for the product group

ACO Product benefits

- For gully top designs for load class D 400, shaft has buoyancy safety up to the upper side of the shaft manhole cover without need for on-site concrete castings.
- Proven stability: 50 years

- Grease separator plant as per DIN EN 1825 and DIN 4040-100
- For underground installation
- Emptying and cleaning via shaft manhole cover
- Suitable top sections
 - Top sections

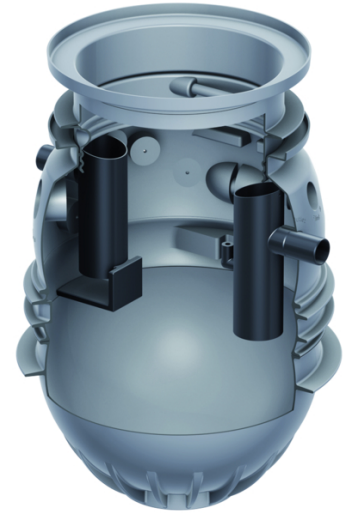

Item Technical Data 3205.80.00



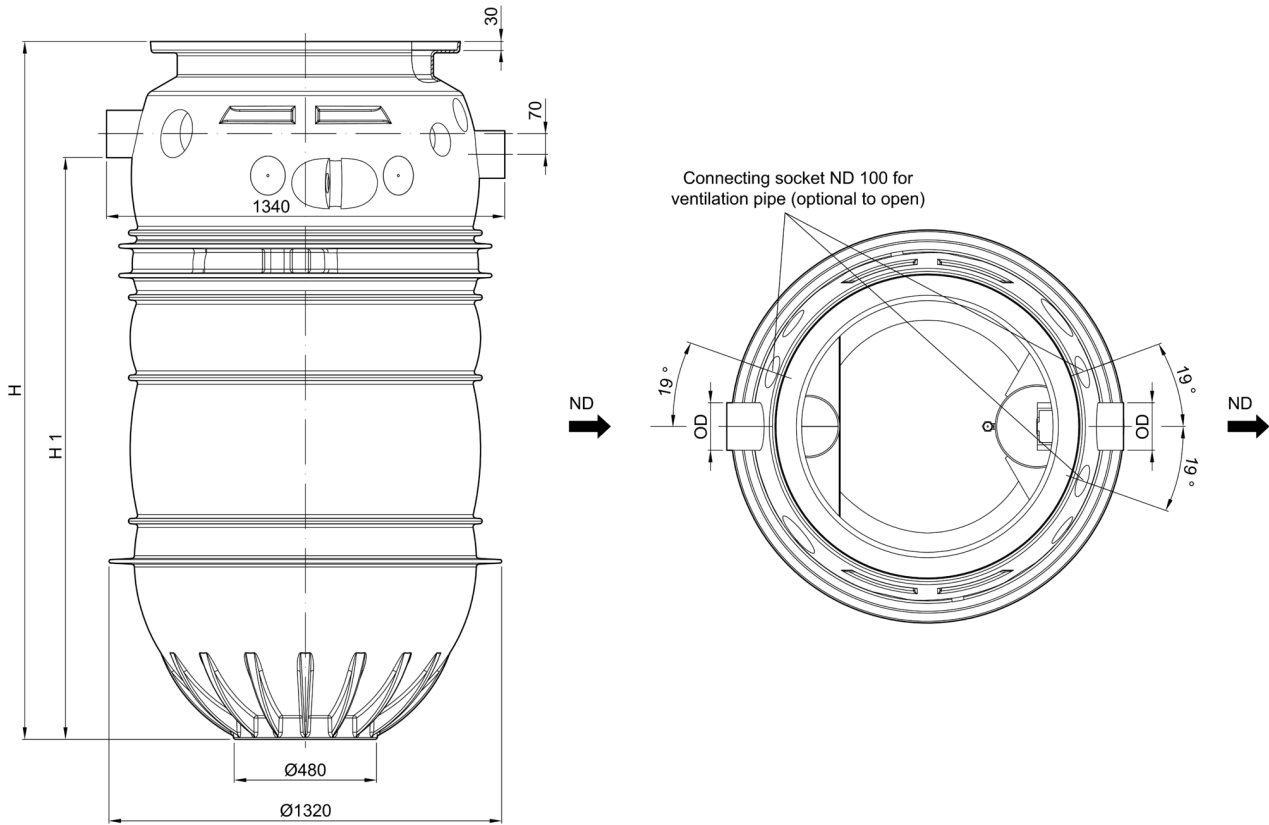

Nominal size	Inlet/ Outlet	Contents			Weight	
		Sludge trap	Grease store	Overall		
		[l]	[l]	[l]	[kg]	
NS 5.5	DN 150	570	230	1465	93	11

Dimensions



Nominal size	Sludge trap	Dimensions		
		D [mm]	H [mm]	H1 [mm]
NS 5.5	570	160	2130	1745

Accessories

	Description	Used with	Weight [kg]	Item number
	<p>Extension 450</p> <ul style="list-style-type: none"> ■ Made from plastic, material polyethylene ■ For fitting on upstream shaft for deep installations ■ Structure height: 100 – 650 mm <ul style="list-style-type: none"> <input type="checkbox"/> (can be reduced to 45 mm by cutting off at cutting marks) ■ Max. two extension can be used 	<ul style="list-style-type: none"> ■ Sampling shaft 	8.8	3300.13.00
	<p>Grease layer thickness measuring device</p> <ul style="list-style-type: none"> ■ For electronic measurement of layer of grease ■ Suitable for liquid and/or congealing grease ■ Measuring device with plug and used connecting cable, length: 3 m ■ With two voltage-free changeover contacts to display full warning (100%) and advance warning of fill level (80%) ■ With visual display of fill level for advance warning and full warning ■ With heated probe rod to increase reliability of operation ■ Operating voltage: 230 V/50 Hz ■ Max consumption approx. 12W 	<ul style="list-style-type: none"> ■ Grease separator LipuMax-P for underground installation ■ LipuLift-P 		
	Cable length: 10 m		6.4	3300.11.70
	Cable length: 20 m		7.8	3300.11.71
	Cable length: 30 m		9.6	3300.11.72
	<p>Support ring</p> <ul style="list-style-type: none"> ■ Made from concrete ■ Diameter: 625 mm ■ Thickness: 60 mm ■ Without seal ■ Displacement-proof ■ Height <ul style="list-style-type: none"> <input type="checkbox"/> 60 mm excluding mortar joints <input type="checkbox"/> 70 mm including mortar joints 	<ul style="list-style-type: none"> ■ Grease separator LipuMax-P for underground installation ■ Lipulift-P Serie ■ Starch separator FapuMax-P for underground installation 	50.0	8700.20.00
	<p>Support ring</p> <ul style="list-style-type: none"> ■ Made from concrete ■ Diameter: 625 mm ■ Thickness: 80 mm ■ Without seal ■ Displacement-proof ■ Height <ul style="list-style-type: none"> <input type="checkbox"/> 80 mm excluding mortar joints <input type="checkbox"/> 90 mm including mortar joints 	<ul style="list-style-type: none"> ■ Grease separator LipuMax-P for underground installation ■ Lipulift-P Serie ■ Starch separator FapuMax-P for underground installation 	60.0	8700.20.10

	Description	Used with	Weight	Item number
			[kg]	
 <p>Support ring</p> <ul style="list-style-type: none"> ■ Made from concrete ■ Diameter: 625 mm ■ Thickness: 100 mm ■ Without seal ■ Displacement-proof ■ Height <ul style="list-style-type: none"> <input type="checkbox"/> 100 mm excluding mortar joints <input type="checkbox"/> 110 mm including mortar joints 		<ul style="list-style-type: none"> ■ Grease separator LipuMax-P for underground installation ■ Lipulift-P Serie ■ Starch separator FapuMax-P for underground installation 	70.0	8700.20.20

You can find further accessories under → <https://www.buildingdrainage.aco/search/?q=3205.80.00>