

Lipujet-P-OA Extension stage 3

Product information for the product group

ACO Product benefits

- Proven stability: 25 years
- Odour-free emptying, cleaning and filling
- Can be equipped with an disposal pump
- Pre- and post-cleaning times can be set individually
- Hydromechanical high-pressure cleaning – only a cold-water connection required
- Can be equipped with an disposal pump
- Minimises disposal and maintenance costs thanks to economic step increases in nominal size
- Small delivery dimensions
- Low weight

- Grease separator plant as per DIN EN 1825 and DIN 4040-100
- For indoors installation – frost free
- With integrated sludge trap
- Operating side: right/left
- Draining connection, fire hose quick coupling B 2½"
- Suction and emptying sump with drain plug socket 1"
- Inspection window with wiper
- Automatic high-pressure internal cleaning with pump
 - Nominal pressure: 175 bar
 - Capacity: 11,6 l/min
 - Chopping, mixing, rinsing in one process
- Standard control with group fault reporting
- Odour-proof maintenance opening, diameter: 450 mm
- Filling device with magnetic valve (connection ¾") for automatic refilling
- Electrical connector: 400V/50 Hz/16A/4,2 kW

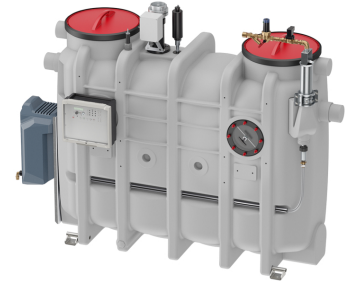

Item Technical Data 3551.74.32

Nominal size	Nominal width	Contents			Weight		Operation side
		Sludge trap	Grease store	Overall	Empty	Full	
		[l]	[l]	[l]	[kg]	[kg]	
NS 1	DN 100	106	100	320	100	420	left

Dimensions

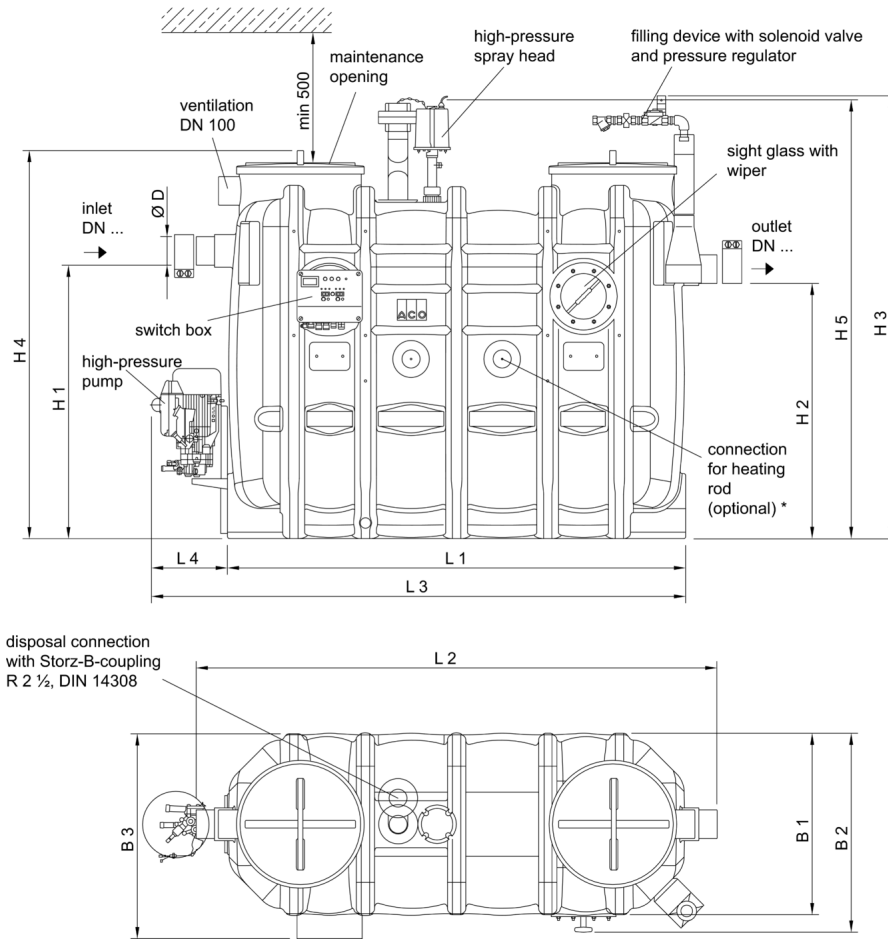

displayed:
 NS4, operating side right,
 operating side left would show all components
 (disposal connection, filling device, sight
 glass, switch box) positioned mirror-inverted
 to axis.





* not included in the scope of delivery

**Nomi-
 nal size**

Dimensions

	L1	L2	L3	L4	H1	H2	H3	H4	H5	B1	B2	B3	D
	[mm]	[mm]	[mm]	[mm]	[mm]	[mm]	[mm]	[mm]	[mm]	[mm]	[mm]	[mm]	[mm]
NS 1	1100	1300	1400	300	830	760	1510	1300	1500	700	770	800	110

Accessories

	Description	Used with	Weight [kg]	Item number
	<p>Sampling pot DN 100</p> <ul style="list-style-type: none"> ■ For installation of horizontal pipes DN 100 to grease separator ■ Round shape with <ul style="list-style-type: none"> <input type="checkbox"/> Coupling socket seal (material SBR) on inlet and spigot on outflow <input type="checkbox"/> Odour-proof maintenance opening DN 450 	<ul style="list-style-type: none"> ■ Grease separator LipuJet-P/LipuSmart-P <ul style="list-style-type: none"> <input type="checkbox"/> NS 1 – 4 ■ Starch separator FapuJet-P-OAP <ul style="list-style-type: none"> <input type="checkbox"/> NS 0.5 – 1 	10.2	3300.09.11
	<p>Sampling pot DN 100</p> <ul style="list-style-type: none"> ■ For installation in vertical pipes DN 100 going to grease separator ■ Round shape with <ul style="list-style-type: none"> <input type="checkbox"/> Coupling socket seal (material SBR) on inlet and spigot on outflow <input type="checkbox"/> Odour-proof maintenance opening DN 450 	<ul style="list-style-type: none"> ■ Grease separator LipuJet-P/LipuSmart-P <ul style="list-style-type: none"> <input type="checkbox"/> NS 1 – 4 ■ Starch separator FapuJet-P-OAP <ul style="list-style-type: none"> <input type="checkbox"/> NS 0.5 – 1 	10.2	3300.10.11
	<p>Viewing window</p> <ul style="list-style-type: none"> ■ Nominal width: DN 200 ■ With screen wiper 	<ul style="list-style-type: none"> ■ Grease separator <ul style="list-style-type: none"> <input type="checkbox"/> LipuJet-P-OB/OD/R/RD <input type="checkbox"/> LipuSmart-P-OB/OD ■ BioJet-P-OM/RM (NS 2-25) 	3.2	3300.11.10
	<p>Filling device</p> <ul style="list-style-type: none"> ■ Free outlet as per DIN 1988 Part 4 ■ For connection to drinking water supply ■ With DVGW / KIWA approval and inclined valve R 3/4 " ■ With pressure relief valve with dirt trap 	<ul style="list-style-type: none"> ■ Grease separator <ul style="list-style-type: none"> <input type="checkbox"/> LipuJet-P-OB/OD/R/RD <input type="checkbox"/> LipuSmart-P-OB/OD ■ BioJet-P-OM/RM (NS 2-25) 	3.5	3300.11.22
	<p>Grease layer thickness measuring device</p> <ul style="list-style-type: none"> ■ For electronic measurement of layer of grease ■ Suitable for liquid and/or congealing grease ■ Measuring device with plug and used connecting cable, length: 3 m ■ With two voltage-free changeover contacts to display full warning (80%) and advance warning of fill level (50%) ■ With visual display of fill level ■ With heated probe rod to increase reliability of operation ■ Operating voltage: 230VAC/5 VA ■ Max consumption approx. 12W 	<ul style="list-style-type: none"> ■ LipuJet-P <ul style="list-style-type: none"> <input type="checkbox"/> Oval NS 1 – 10 <input type="checkbox"/> Round NS 2 – 22,5 ■ LipuJet-S <ul style="list-style-type: none"> <input type="checkbox"/> Oval NS 1 – 10 <input type="checkbox"/> Round NS 2 – 20 ■ LipuSmart-P <ul style="list-style-type: none"> <input type="checkbox"/> Oval NS 1 – 10 	2.8	3300.11.50

You can find further accessories under → <https://www.buildingdrainage.aco/search/?q=3551.74.32>