

# LipuJet-P-OA Extension stage 3

## Product information for the product group

### ACO Product benefits

- Proven stability: 25 years
  - Odour-free emptying, cleaning and filling
  - Can be equipped with an disposal pump
  - Pre- and post-cleaning times can be set individually
  - Hydromechanical high-pressure cleaning – only a cold-water connection required
  - Can be equipped with an disposal pump
  - Minimises disposal and maintenance costs thanks to economic step increases in nominal size
  - Small delivery dimensions
  - Low weight
- Grease separator plant as per DIN EN 1825 and DIN 4040-100
  - For indoors installation – frost free
  - With integrated sludge trap
  - Operating side: right/left
  - Draining connection, fire hose quick coupling B 2½"
  - Suction and emptying sump with drain plug socket 1"
  - Inspection window with wiper
  - Automatic high-pressure internal cleaning with pump
    - Nominal pressure: 175 bar
    - Capacity: 11,6 l/min
    - Chopping, mixing, rinsing in one process
  - Standard control with group fault reporting
  - Odour-proof maintenance opening, diameter: 450 mm
  - Filling device with magnetic valve (connection ¾") for automatic refilling
  - Electrical connector: 400V/50 Hz/16A/4,2 kW

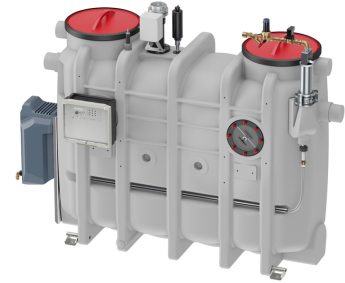

## Item Technical Data 3552.74.32

Nominal size	Nominal width	Contents			Weight		Operation side
		Sludge trap	Grease store	Overall	Empty	Full	
		[l]	[l]	[l]	[kg]	[kg]	
NS 2	DN 100	210	100	440	105	545	left

**Dimensions**

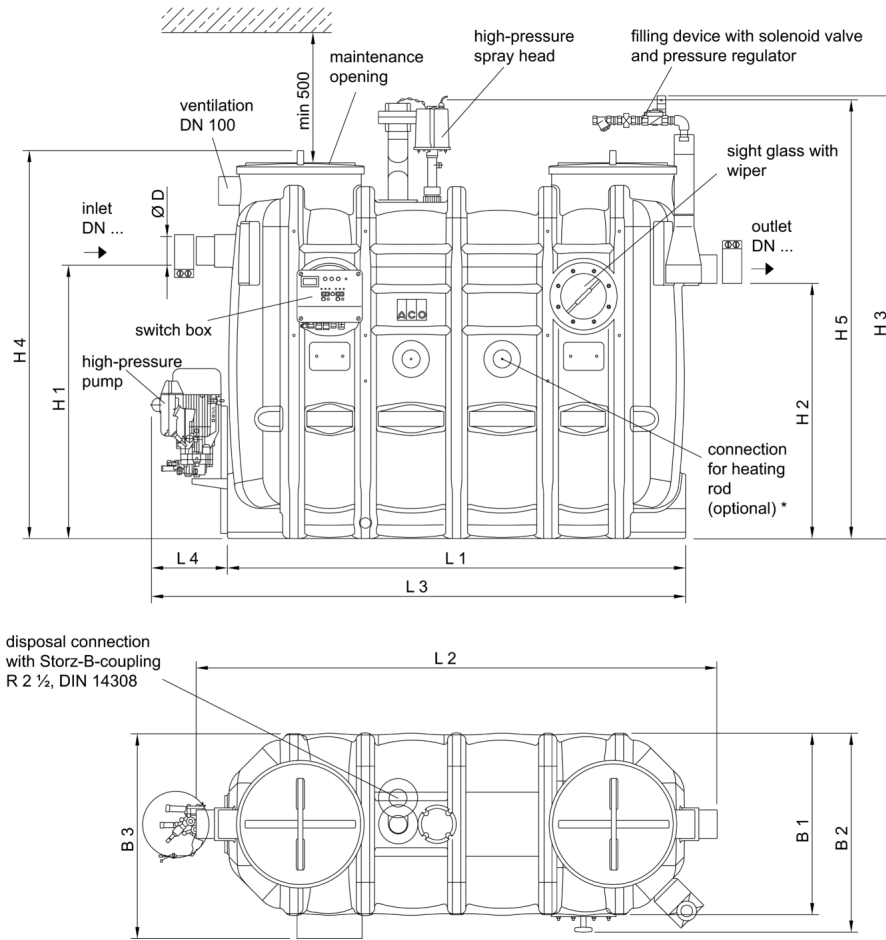

displayed:  
 NS4, operating side right,  
 operating side left would show all components  
 (disposal connection, filling device, sight  
 glass, switch box) positioned mirror-inverted  
 to axis.





\* not included in the scope of delivery

**Nomi-  
 nal size**

**Dimensions**

	L1	L2	L3	L4	H1	H2	H3	H4	H5	B1	B2	B3	D
	[mm]	[mm]	[mm]	[mm]	[mm]	[mm]	[mm]	[mm]	[mm]	[mm]	[mm]	[mm]	[mm]
NS 2	1100	1300	1400	300	1055	985	1710	1500	1700	700	770	800	110

**Accessories**

	Description	Used with	Weight [kg]	Item number
	<p><b>Sampling pot DN 100</b></p> <ul style="list-style-type: none"> <li>■ For installation of horizontal pipes DN 100 to grease separator</li> <li>■ Round shape with                             <ul style="list-style-type: none"> <li><input type="checkbox"/> Coupling socket seal (material SBR) on inlet and spigot on outflow</li> <li><input type="checkbox"/> Odour-proof maintenance opening DN 450</li> </ul> </li> </ul>	<ul style="list-style-type: none"> <li>■ Grease separator LipuJet-P/LipuSmart-P                             <ul style="list-style-type: none"> <li><input type="checkbox"/> NS 1 – 4</li> </ul> </li> <li>■ Starch separator FapuJet-P-OAP                             <ul style="list-style-type: none"> <li><input type="checkbox"/> NS 0.5 – 1</li> </ul> </li> </ul>	10.2	3300.09.11
	<p><b>Sampling pot DN 100</b></p> <ul style="list-style-type: none"> <li>■ For installation in vertical pipes DN 100 going to grease separator</li> <li>■ Round shape with                             <ul style="list-style-type: none"> <li><input type="checkbox"/> Coupling socket seal (material SBR) on inlet and spigot on outflow</li> <li><input type="checkbox"/> Odour-proof maintenance opening DN 450</li> </ul> </li> </ul>	<ul style="list-style-type: none"> <li>■ Grease separator LipuJet-P/LipuSmart-P                             <ul style="list-style-type: none"> <li><input type="checkbox"/> NS 1 – 4</li> </ul> </li> <li>■ Starch separator FapuJet-P-OAP                             <ul style="list-style-type: none"> <li><input type="checkbox"/> NS 0.5 – 1</li> </ul> </li> </ul>	10.2	3300.10.11
	<p><b>Viewing window</b></p> <ul style="list-style-type: none"> <li>■ Nominal width: DN 200</li> <li>■ With screen wiper</li> </ul>	<ul style="list-style-type: none"> <li>■ Grease separator                             <ul style="list-style-type: none"> <li><input type="checkbox"/> LipuJet-P-OB/OD/R/RD</li> <li><input type="checkbox"/> LipuSmart-P-OB/OD</li> </ul> </li> <li>■ BioJet-P-OM/RM (NS 2-25)</li> </ul>	3.2	3300.11.10
	<p><b>Filling device</b></p> <ul style="list-style-type: none"> <li>■ Free outlet as per DIN 1988 Part 4</li> <li>■ For connection to drinking water supply</li> <li>■ With DVGW / KIWA approval and inclined valve R 3/4 "</li> <li>■ With pressure relief valve with dirt trap</li> </ul>	<ul style="list-style-type: none"> <li>■ Grease separator                             <ul style="list-style-type: none"> <li><input type="checkbox"/> LipuJet-P-OB/OD/R/RD</li> <li><input type="checkbox"/> LipuSmart-P-OB/OD</li> </ul> </li> <li>■ BioJet-P-OM/RM (NS 2-25)</li> </ul>	3.5	3300.11.22
	<p><b>Grease layer thickness measuring device</b></p> <ul style="list-style-type: none"> <li>■ For electronic measurement of layer of grease</li> <li>■ Suitable for liquid and/or congealing grease</li> <li>■ Measuring device with plug and used connecting cable, length: 3 m</li> <li>■ With two voltage-free changeover contacts to display full warning (80%) and advance warning of fill level (50%)</li> <li>■ With visual display of fill level</li> <li>■ With heated probe rod to increase reliability of operation</li> <li>■ Operating voltage: 230VAC/5 VA</li> <li>■ Max consumption approx. 12W</li> </ul>	<ul style="list-style-type: none"> <li>■ LipuJet-P                             <ul style="list-style-type: none"> <li><input type="checkbox"/> Oval NS 1 – 10</li> <li><input type="checkbox"/> Round NS 2 – 22,5</li> </ul> </li> <li>■ LipuJet-S                             <ul style="list-style-type: none"> <li><input type="checkbox"/> Oval NS 1 – 10</li> <li><input type="checkbox"/> Round NS 2 – 20</li> </ul> </li> <li>■ LipuSmart-P                             <ul style="list-style-type: none"> <li><input type="checkbox"/> Oval NS 1 – 10</li> </ul> </li> </ul>	2.8	3300.11.50

You can find further accessories under → <https://www.buildingdrainage.aco/search/?q=3552.74.32>